

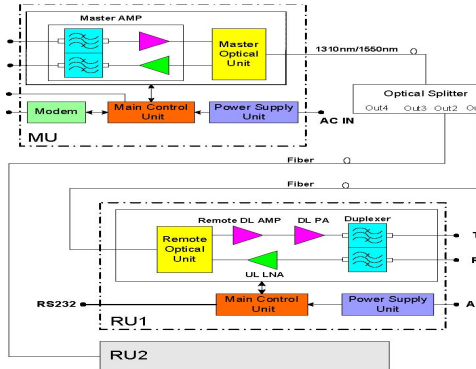

Sunny Fiber Optical Repeater – LTE2600 Full Band 20W

Model: SUN-FOR-L26-FB-20W



Electrical Specifications

Item	Specification	
	Downlink	Uplink
Frequency Range	2620-2690MHz	2500-2570MHz
Output Power (Max.)	43±2dBm	0±2dBm
Gain (Max.) (with 7dB optic loss)	55±3dB	55±3dB
Max. input without damage	10dBm	-10dBm
NF	--	≤5dB
Gain Adjustable Range/Step	≥25dB/1dB	
Gain Adjustable Error	Gain adjustable range is 0~20dB, error≤1dB; ≥21dB, error≤1.5dB	
Ripple	≤3dB in bandwidth	
Downlink 3 rd Order Intercept, OIP3	≥65dBm	--
ALC	When adding ≤10dB at max. Output level, output variation ≤±2dB, When adding >10dB, output variation ≤±2dB or be off.	
VSWR	≤1.5	
Time Delay	≤5.0μs	
Intermodulation (IM3@2x40dBm)	≤-45dBc/30kHz@downlink band ≤-155dBc/30kHz@uplink band	
Spurious Emission	≤-36dBm @9kHz-1GHz, ≤-30dBm @1GHz-12.75GHz	

Optical Specifications

Optical Output Power	0~3dBm
Optical length	DL: 1310nm, UL: 1550nm
Optical Loss	≤10dB /Includes the loss of the optical splitter
Optical Connector	FC/APC

Power Supply and Mechanical Specifications

Model	SUN-FOR-L26-FB-20W-MUx*	SUN-FOR-L26-FB-20W-RU
Power Supply	AC220V±60V,45~55Hz	
Dimension	TBAL	TBAL
Weight	TBAL	TBAL
Max. Power Consumption	≤240W	≤300W
Operating Temperature	-5~+45℃	-25~+55℃
Operating Humidity	≤85%	≤95%
Environmental Class	IP20	IP65
RF Connector	N-Female, 50ohm	
MTBF	≥50000 hours	
Monitor Interface	Local Monitor: RS232, Remote Monitor: UMTS modem	

* x means to support the number of RU X 1-8

Technical data are subjected to change without notice – File: SUN-FOR-L26-FB-20W datasheet 2017V1.0